

A-A

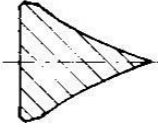

B-B

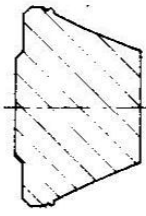

C-C

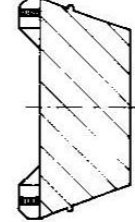

D-D

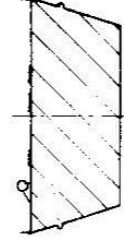

E-E

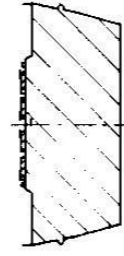

H-H

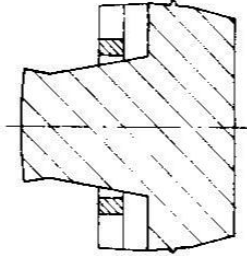

J-J

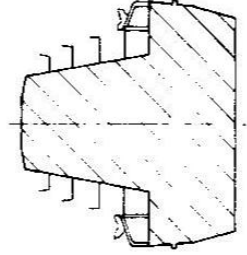

K-K

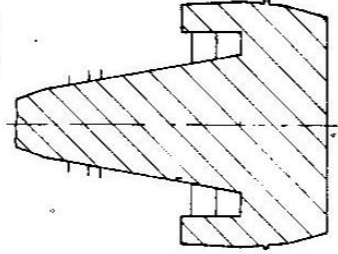

L-L

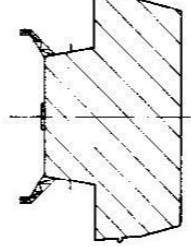

M-M

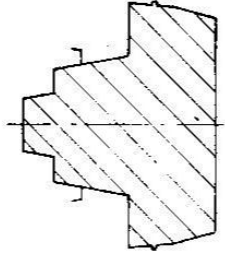

N-N

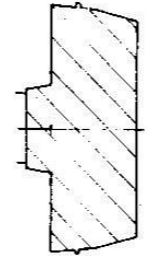

O-O



P-P

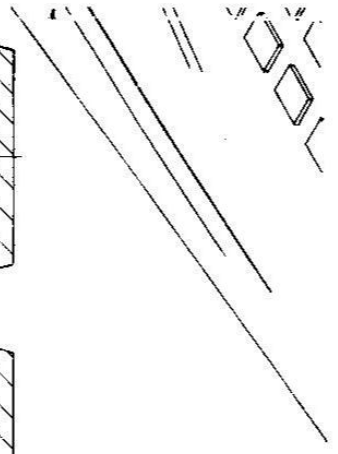
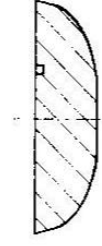

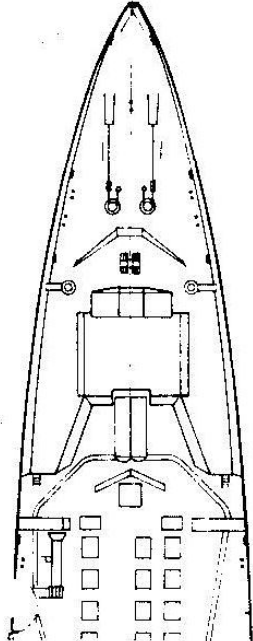
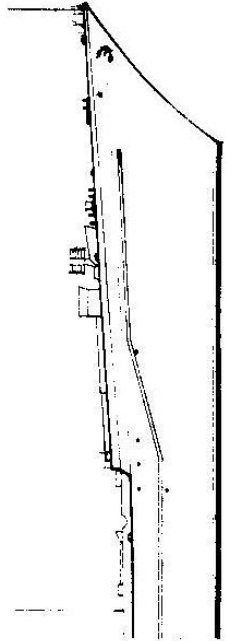
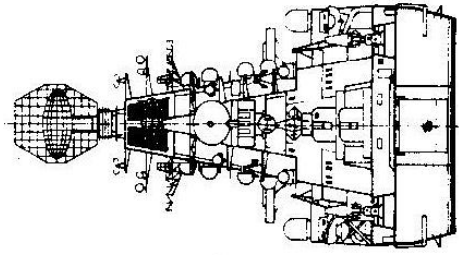
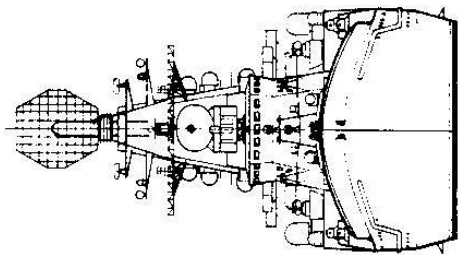

10m

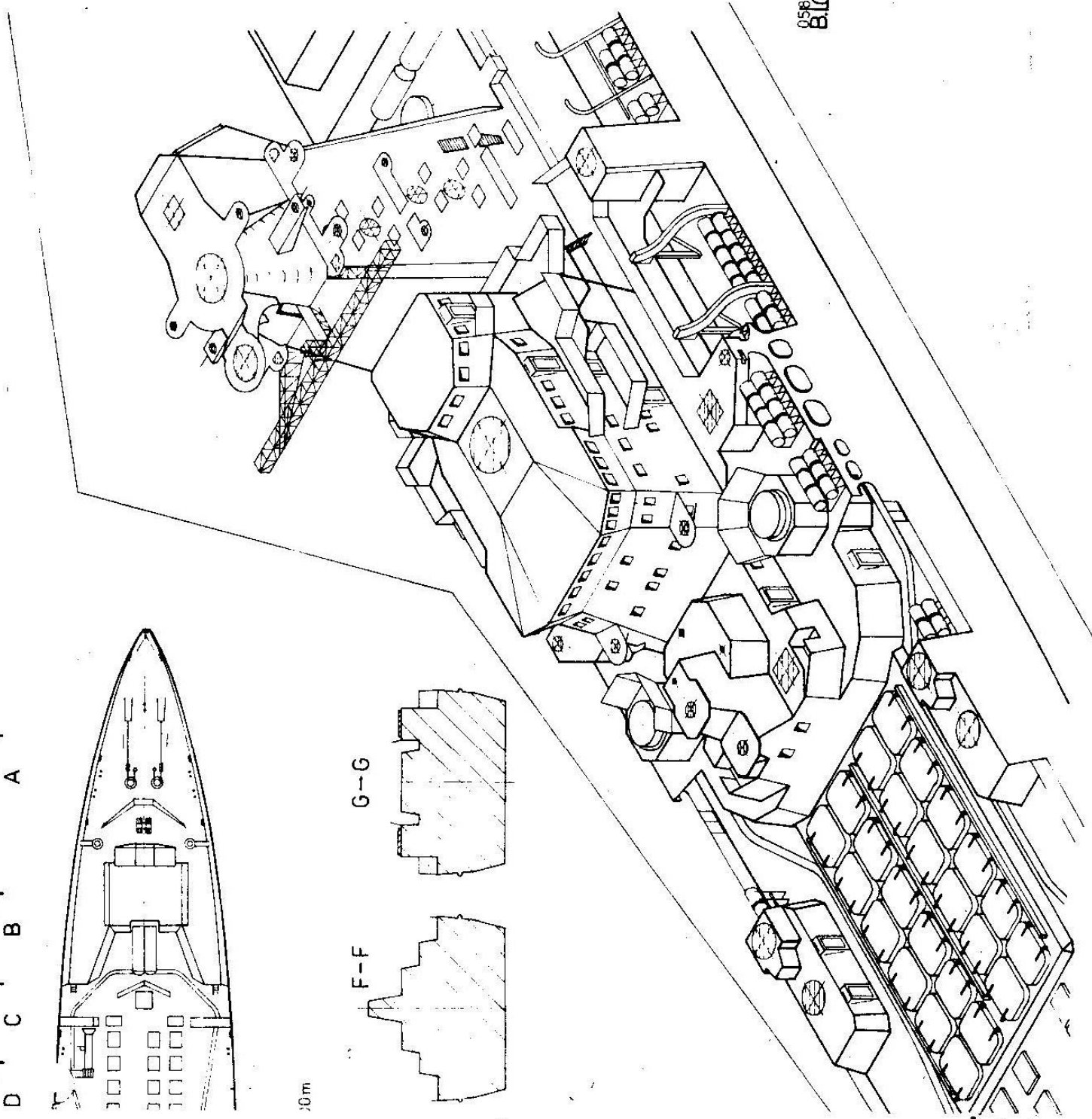
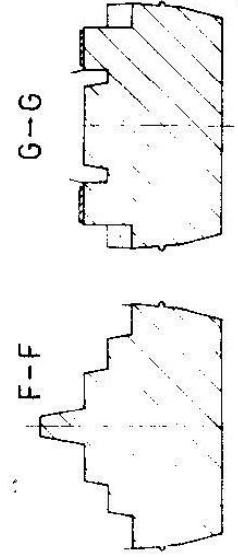

0592
810

M 1:1000



1/100 (2) TOP DOME (VOLNA)
missile guidance system for SA-N-6.
range: 40 nm. I/J band.

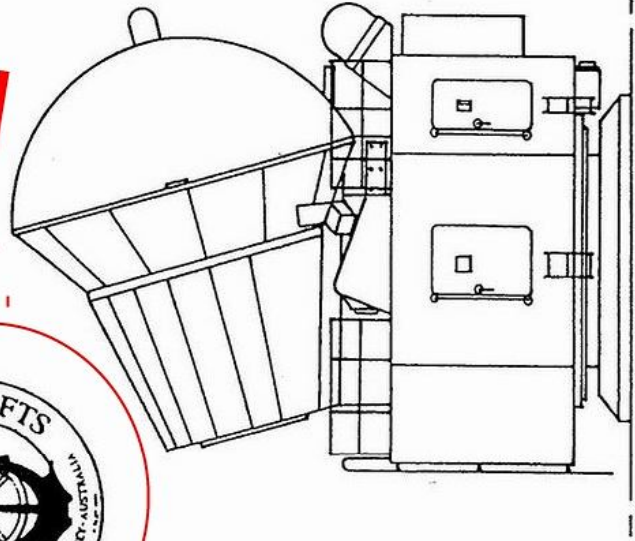

side view

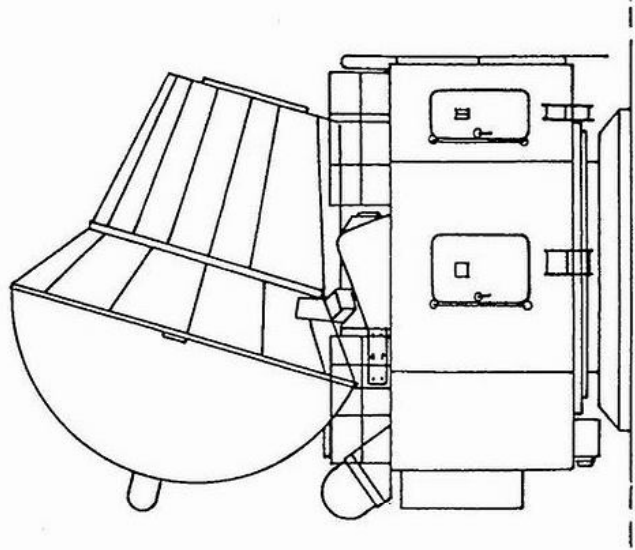

side view

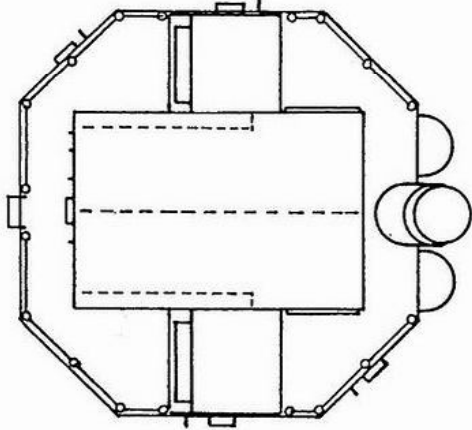

top view

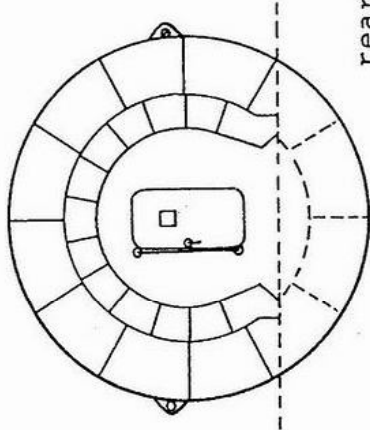

rear view

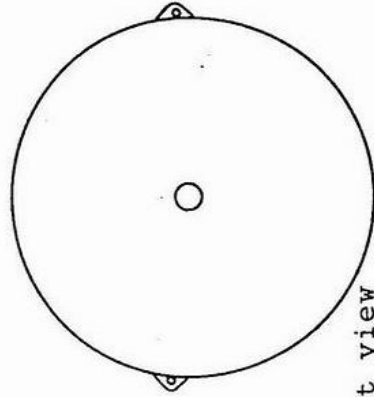

front view

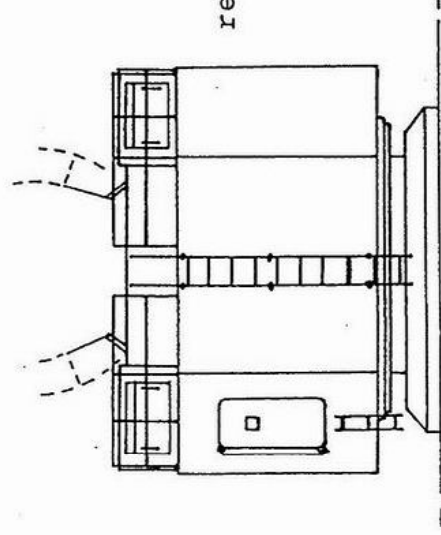

rear front views

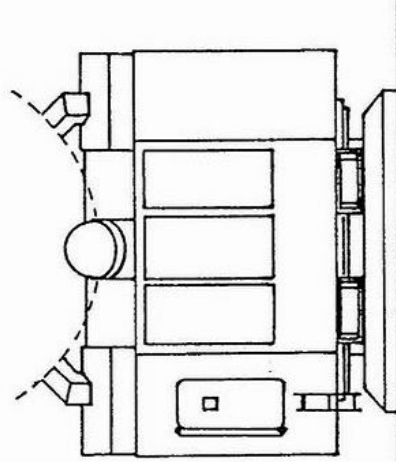

10-1

