

Fig. 1

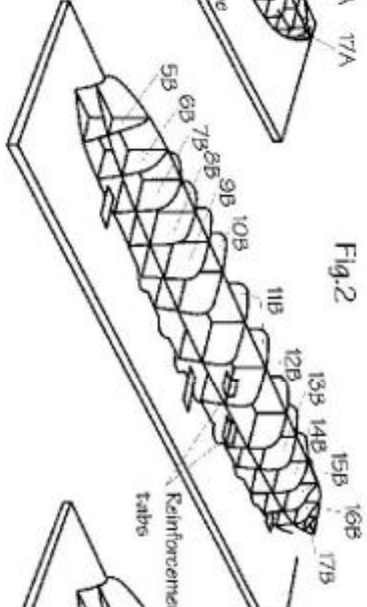

Fig. 2

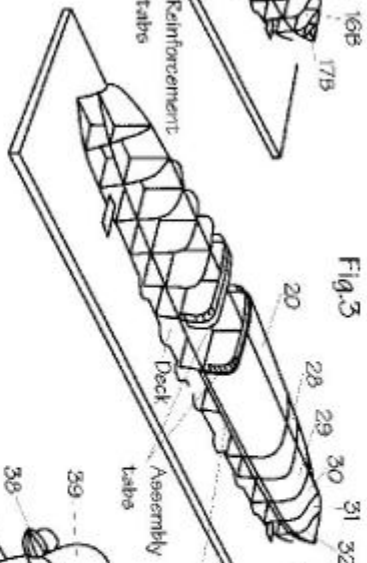

Fig. 3

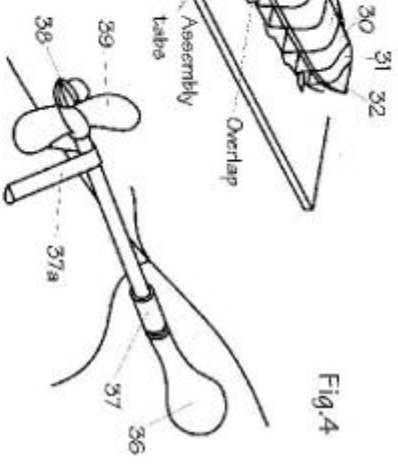

Fig. 4

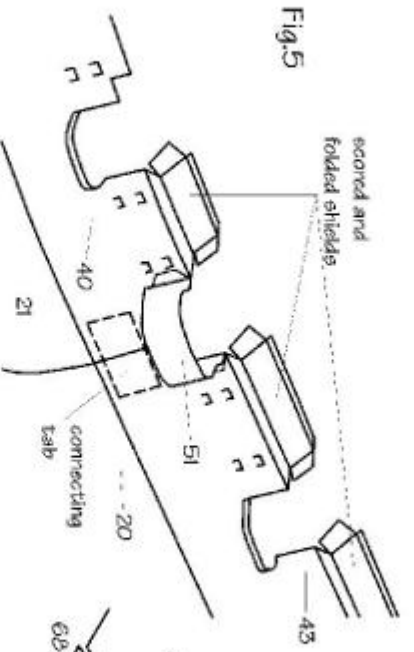

Fig. 5

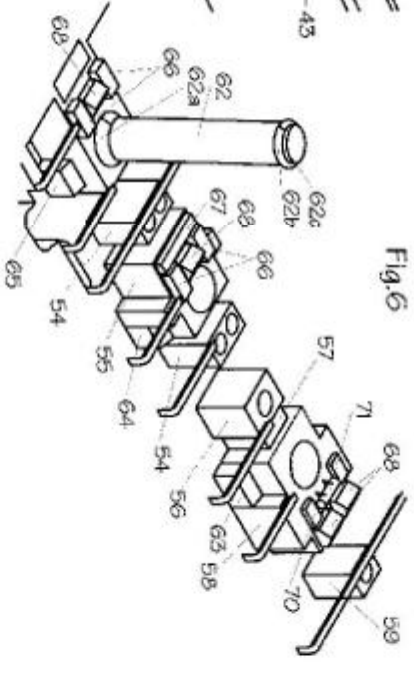

Fig. 6

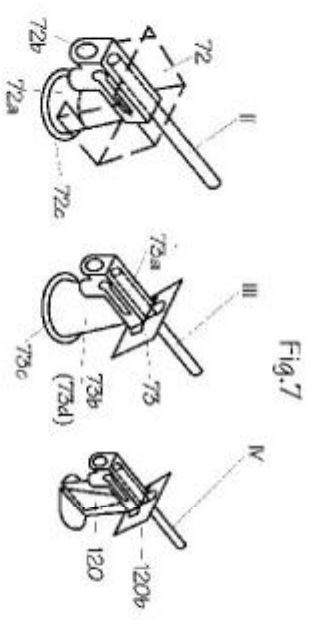

Fig. 7

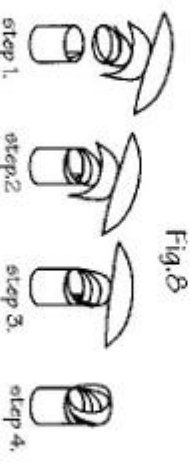

Fig. 8

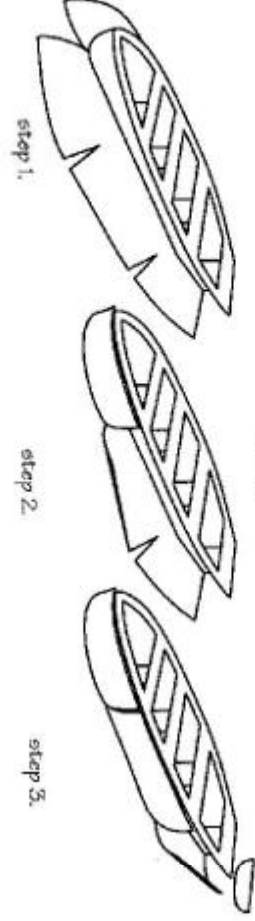

Fig. 12

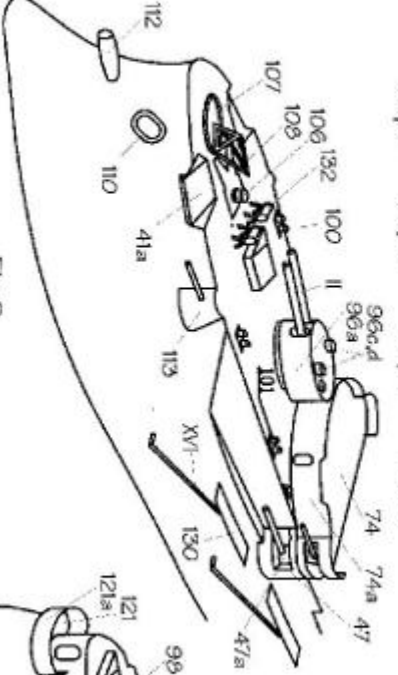

Fig. 9

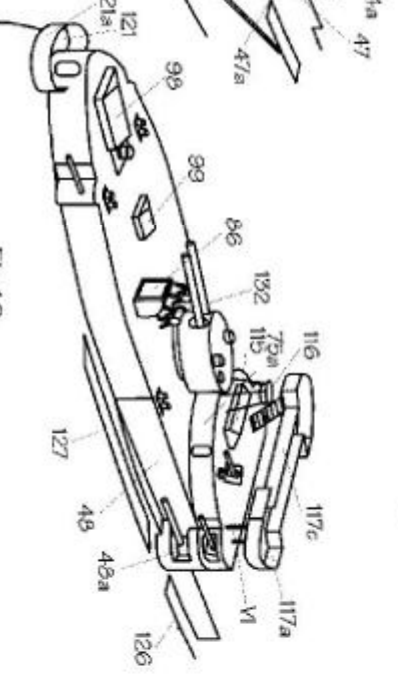

Fig. 10

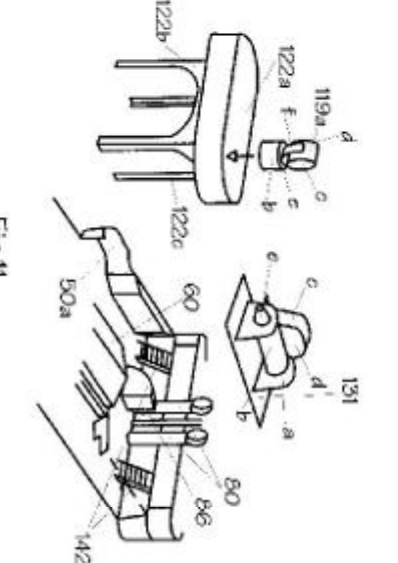
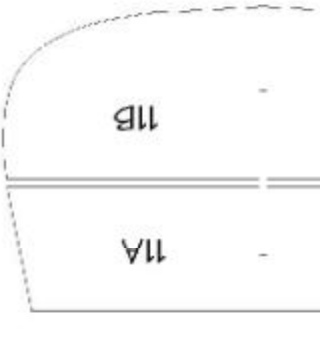
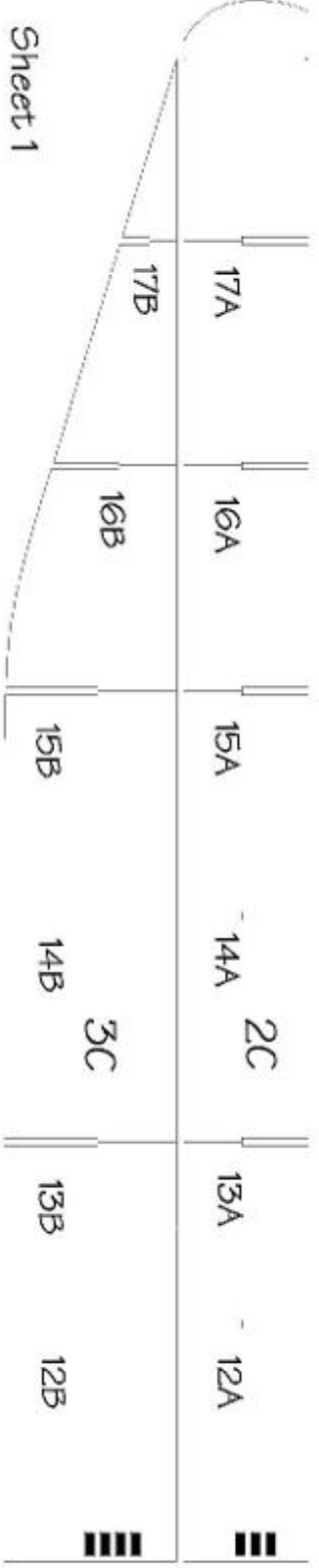
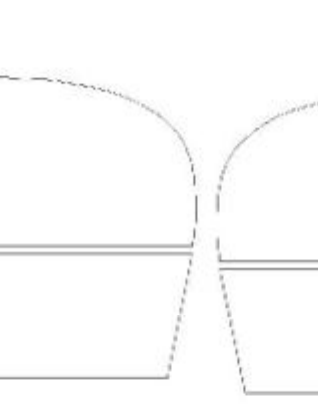
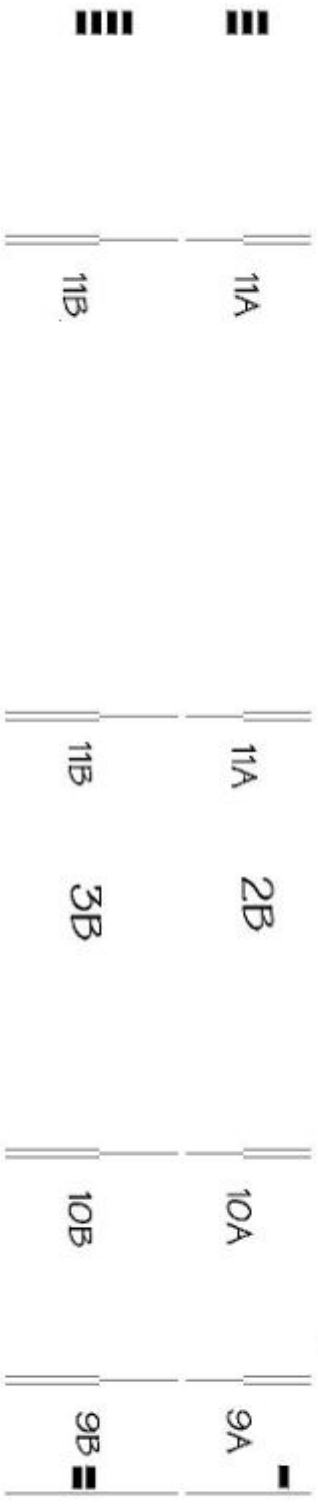
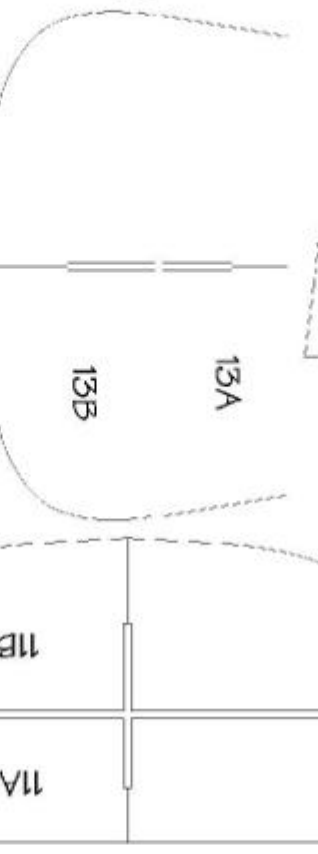
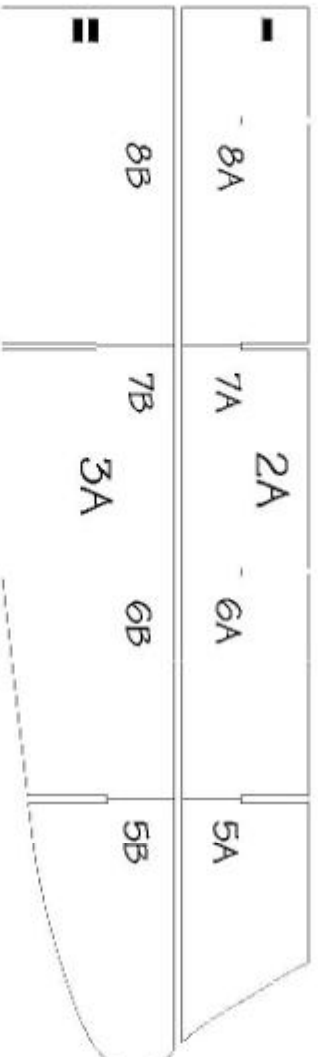
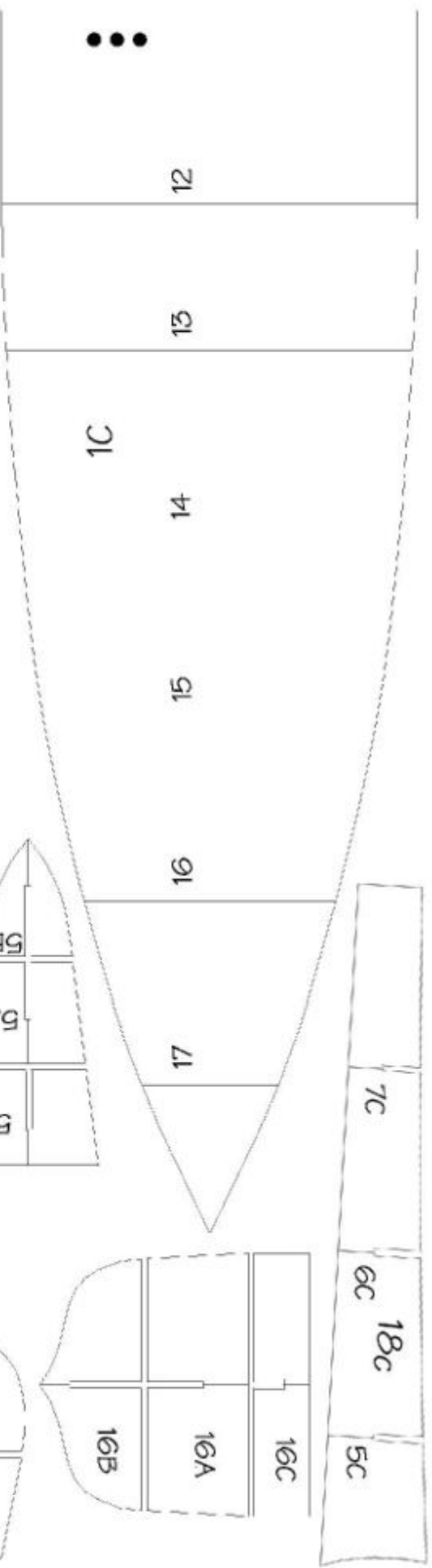
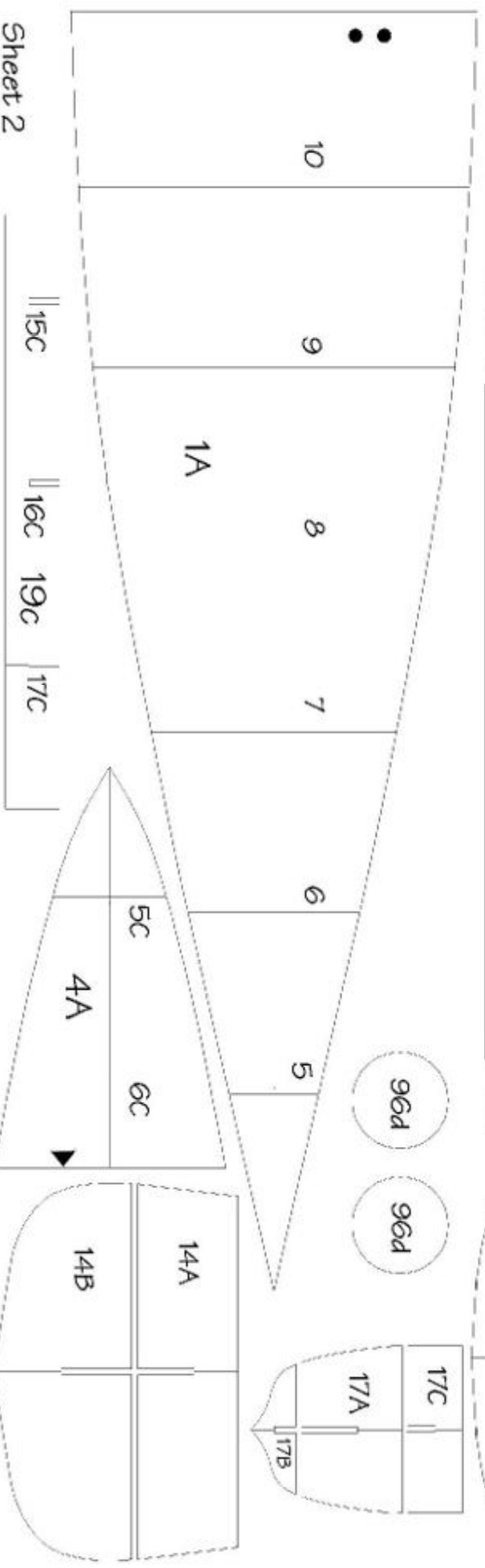
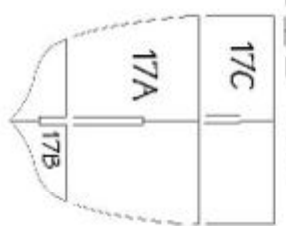
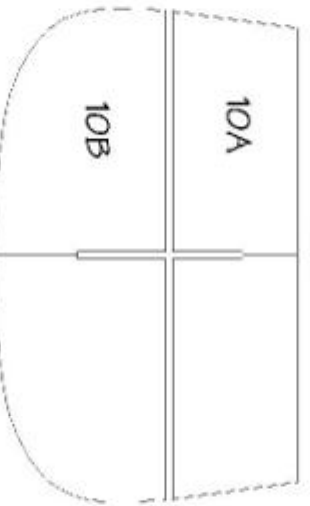
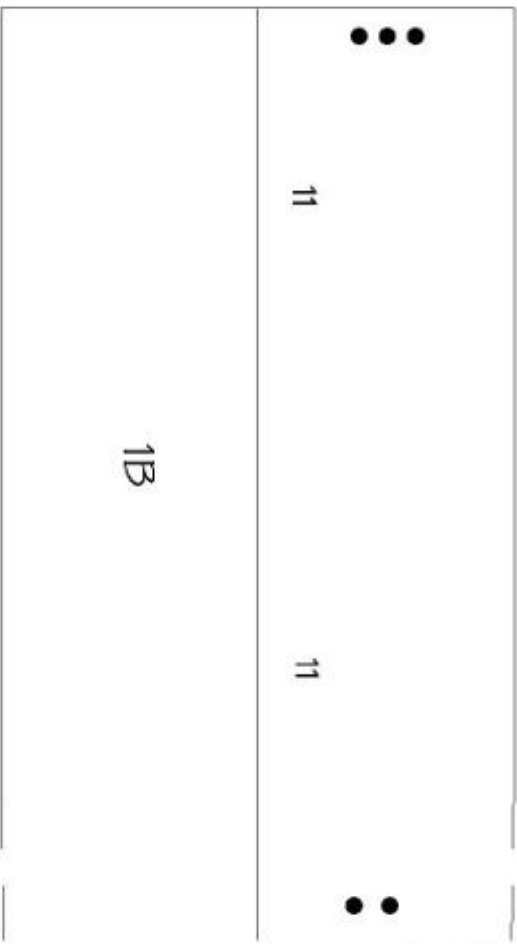
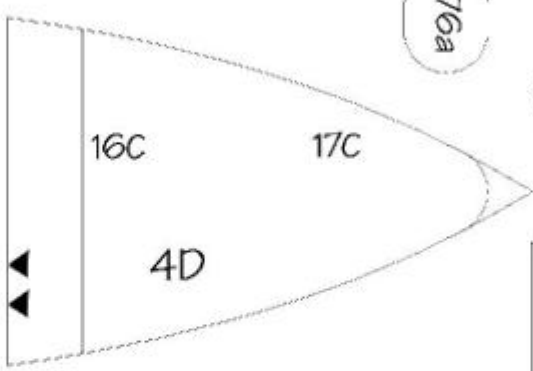
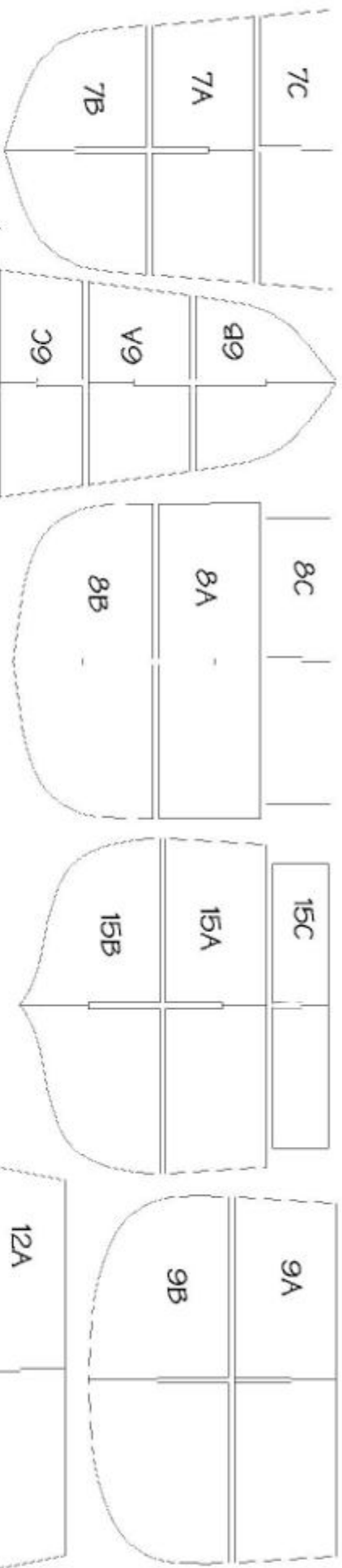
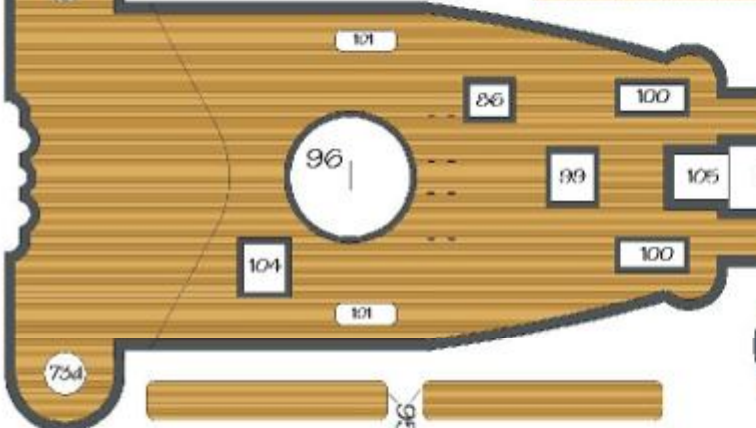
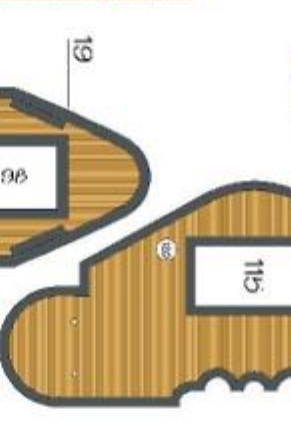
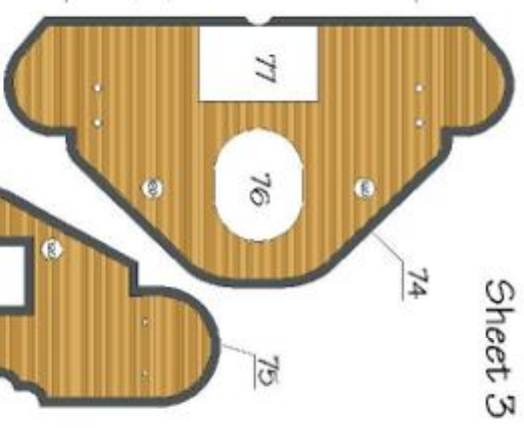
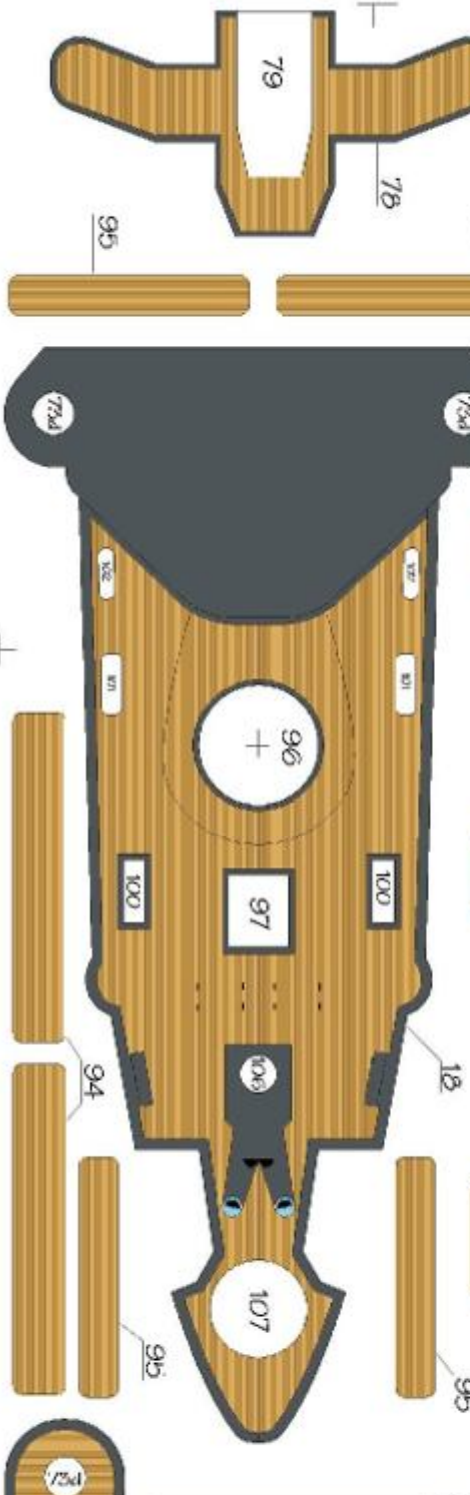
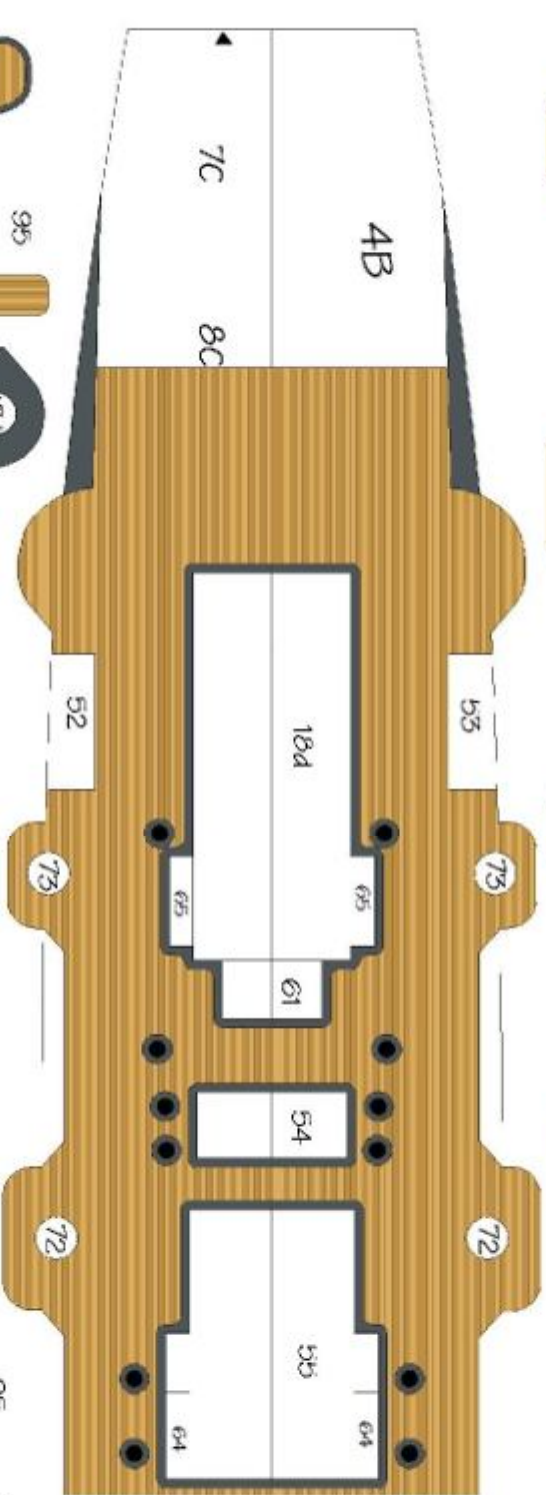
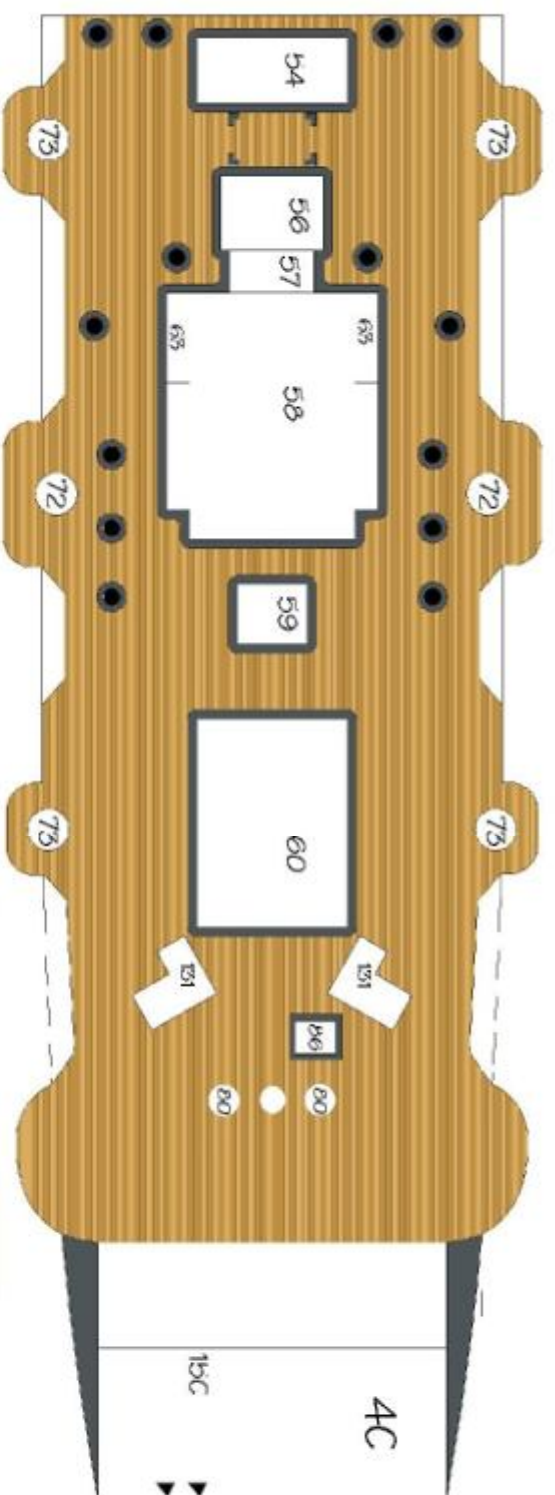
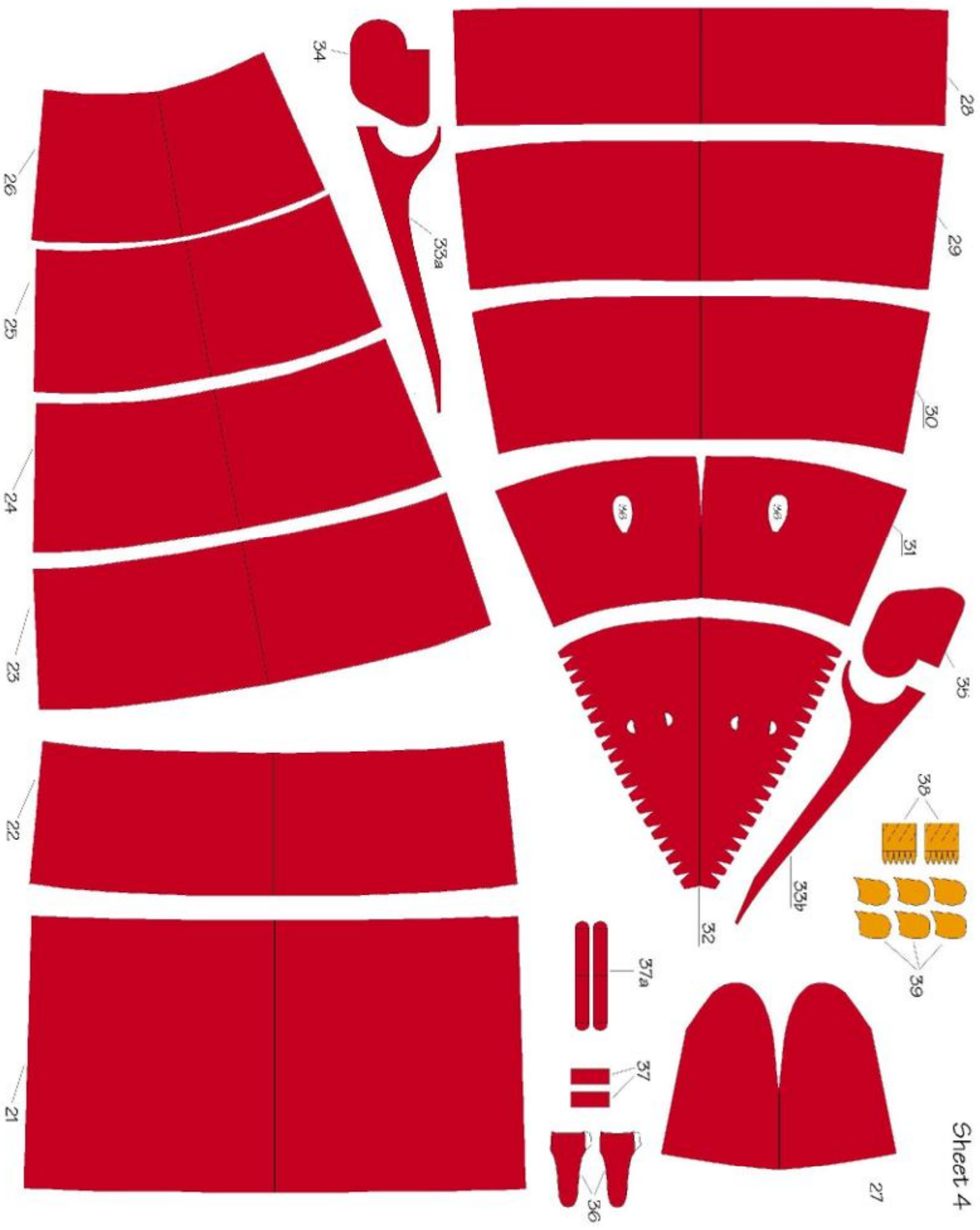

Fig. 11









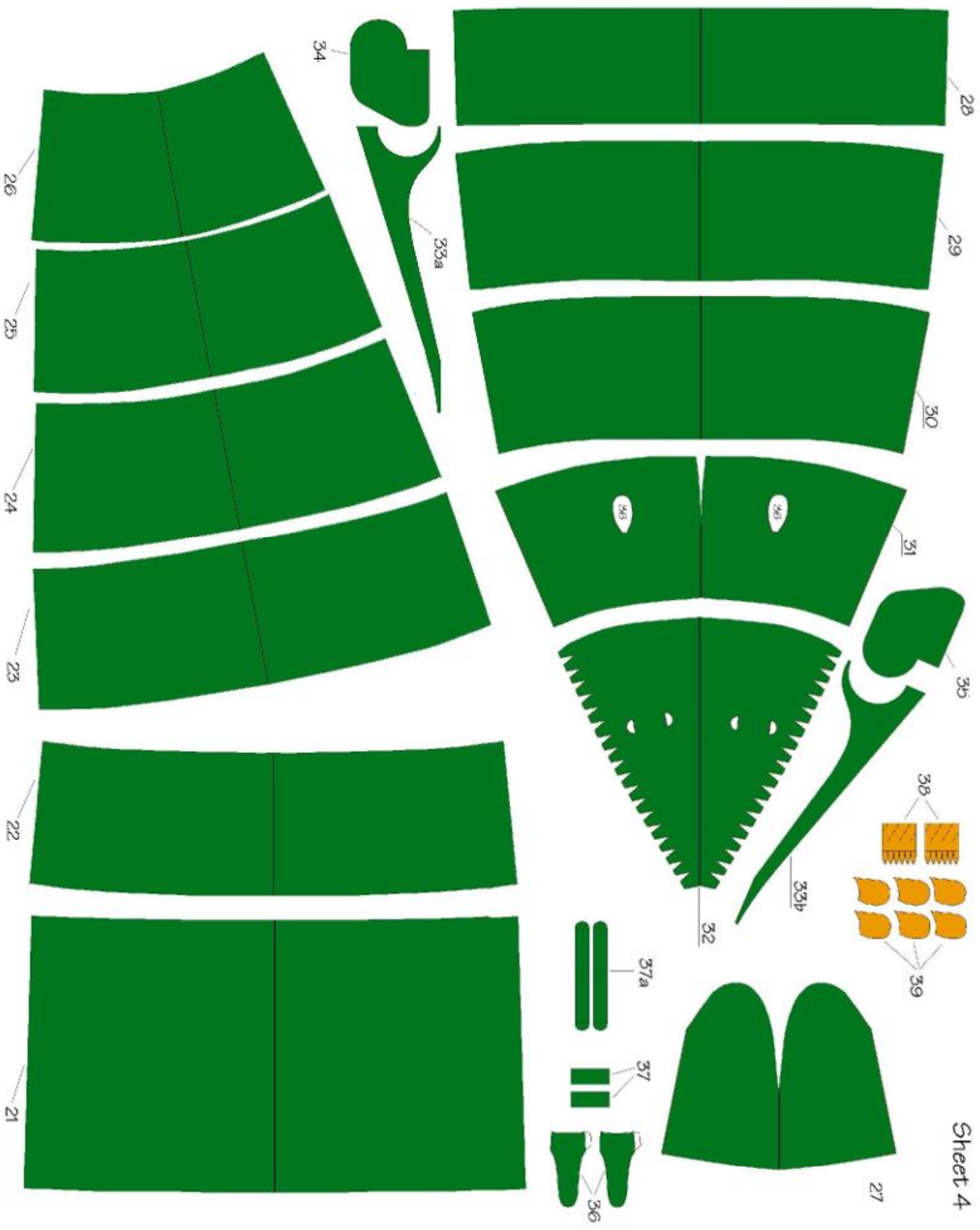



115
139a

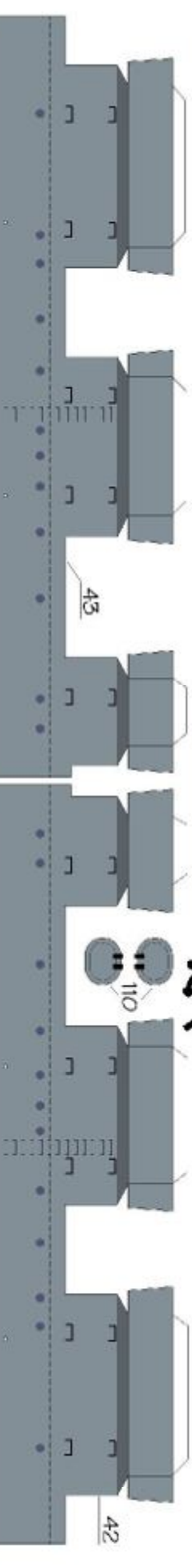
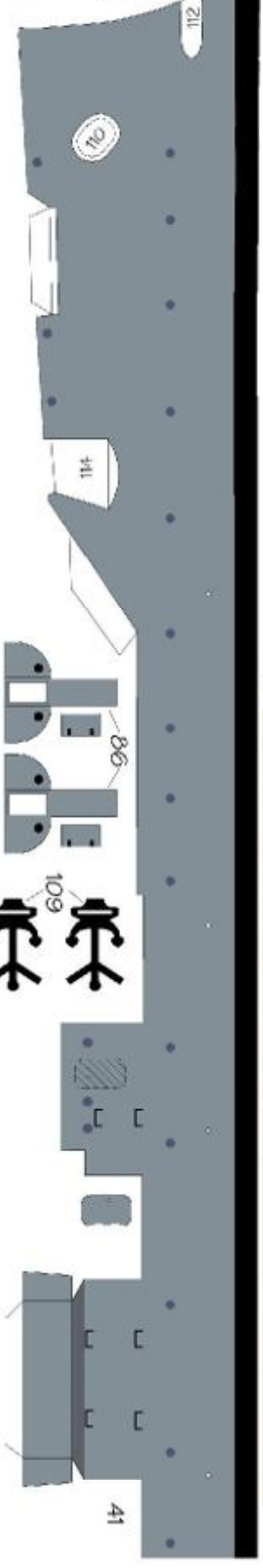
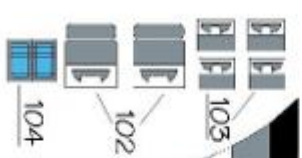
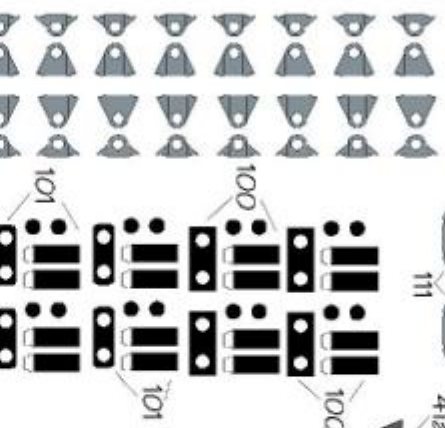
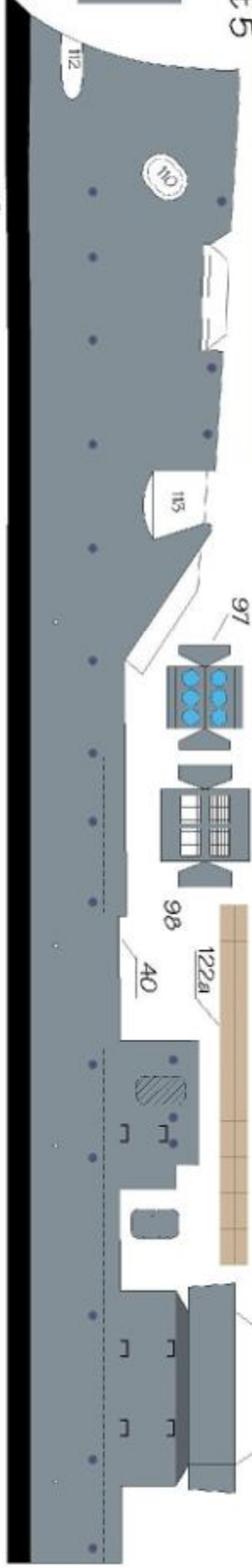

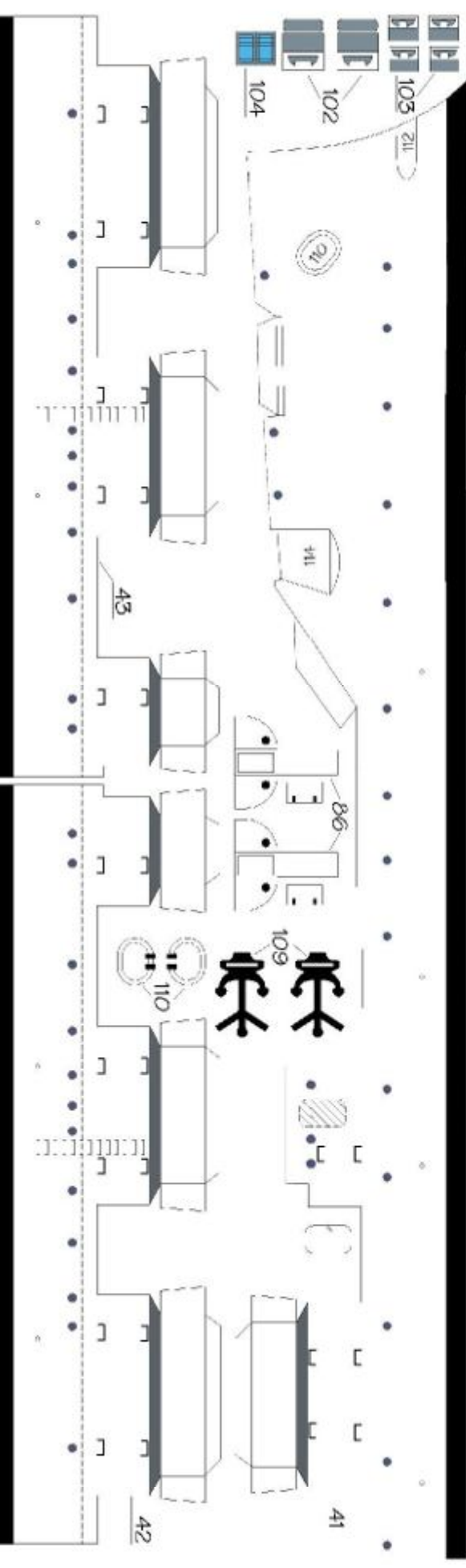
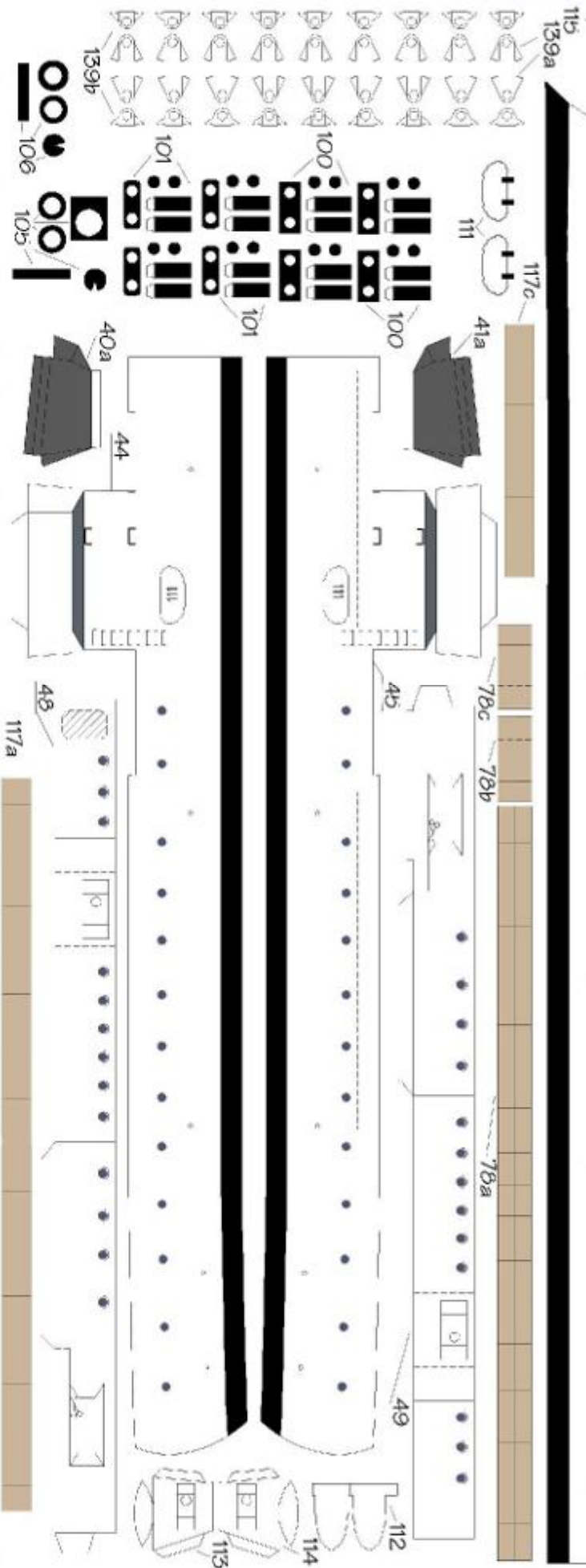
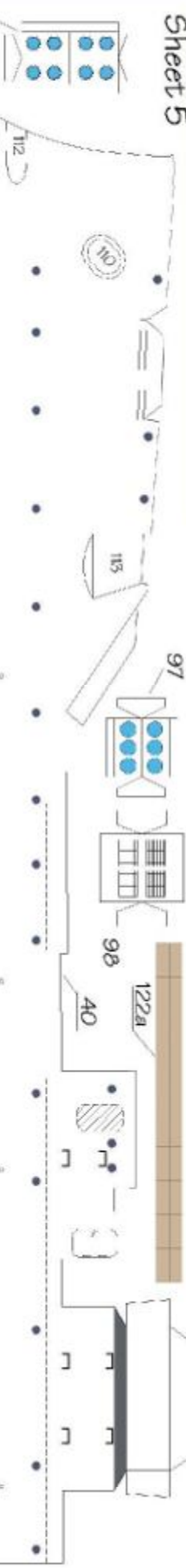

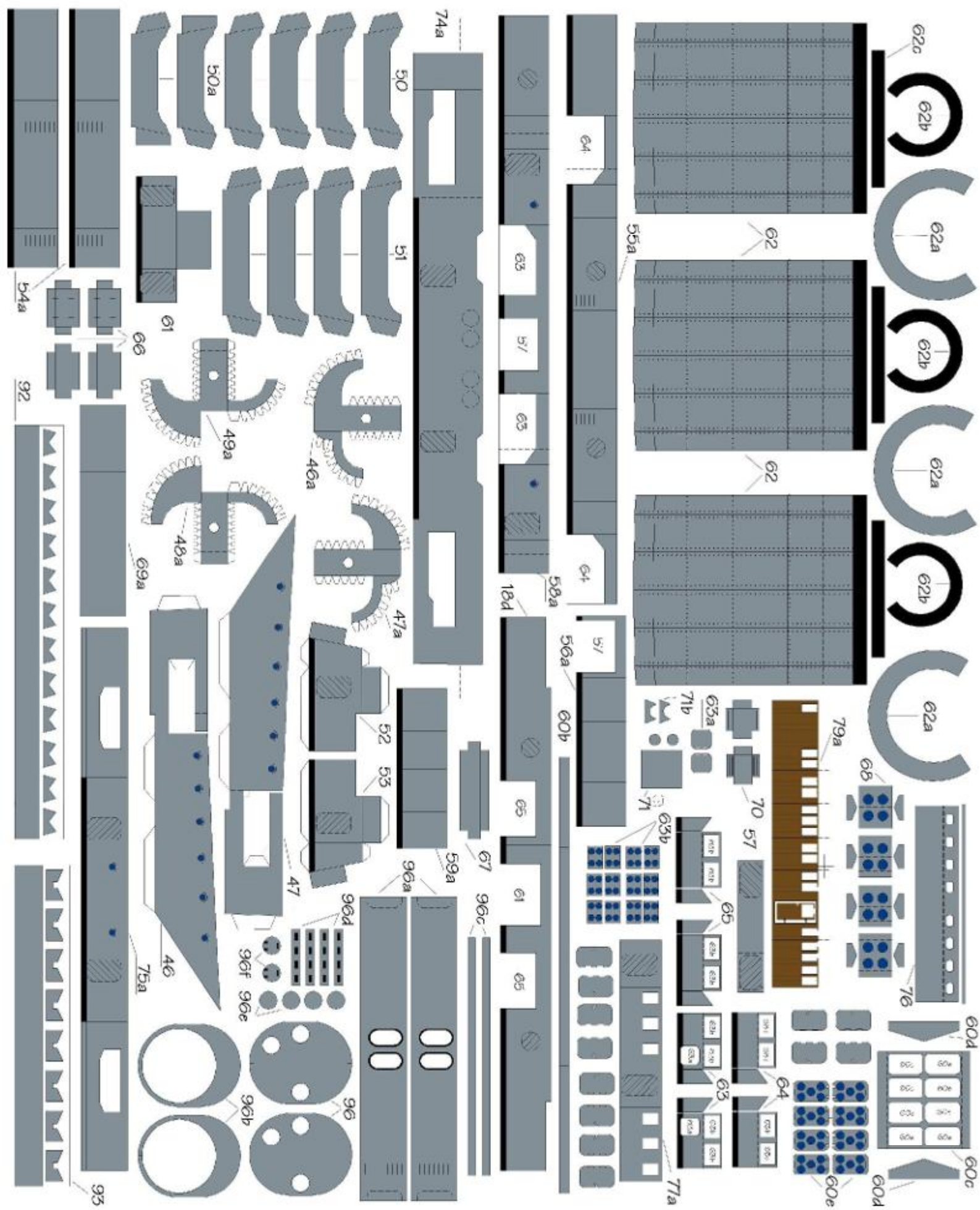

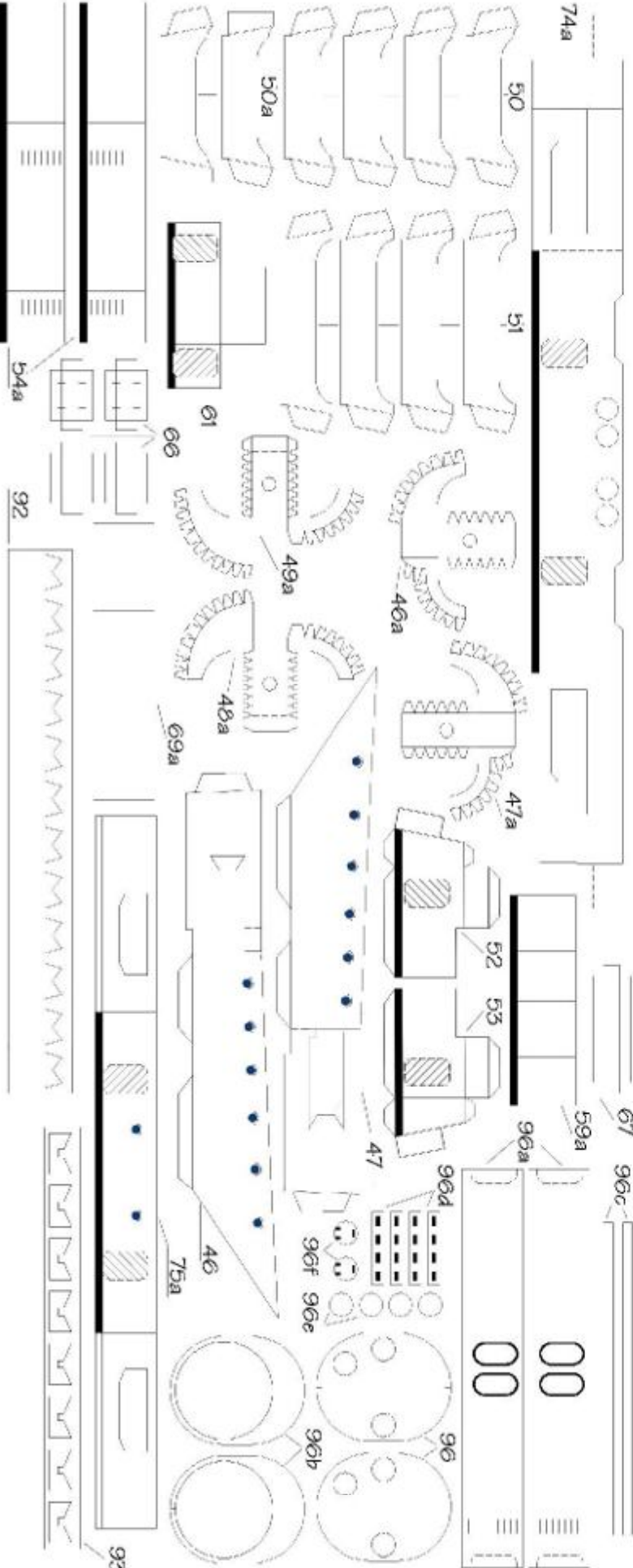
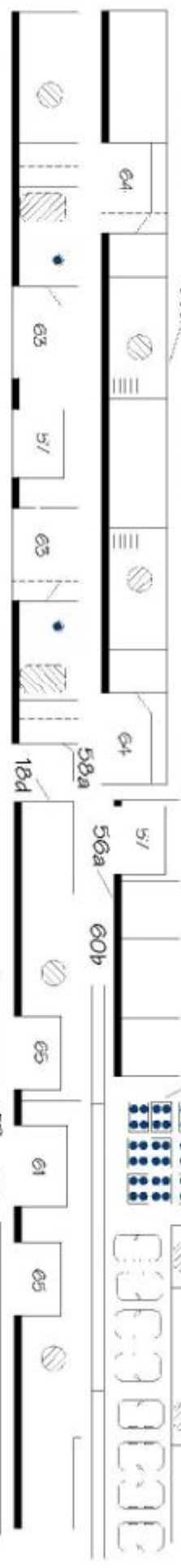
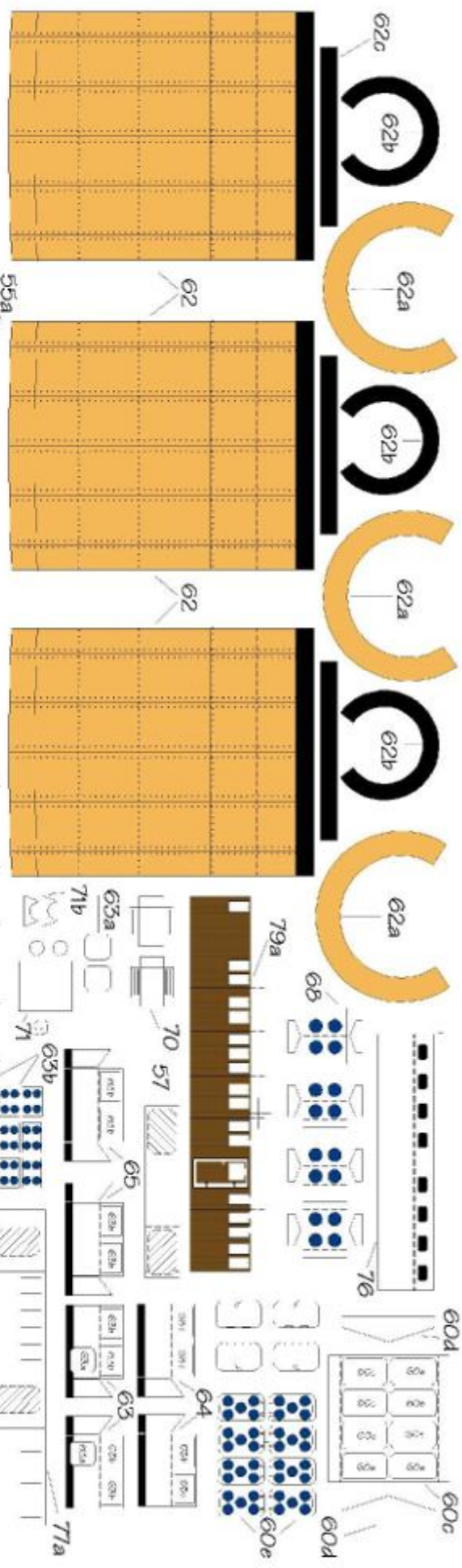

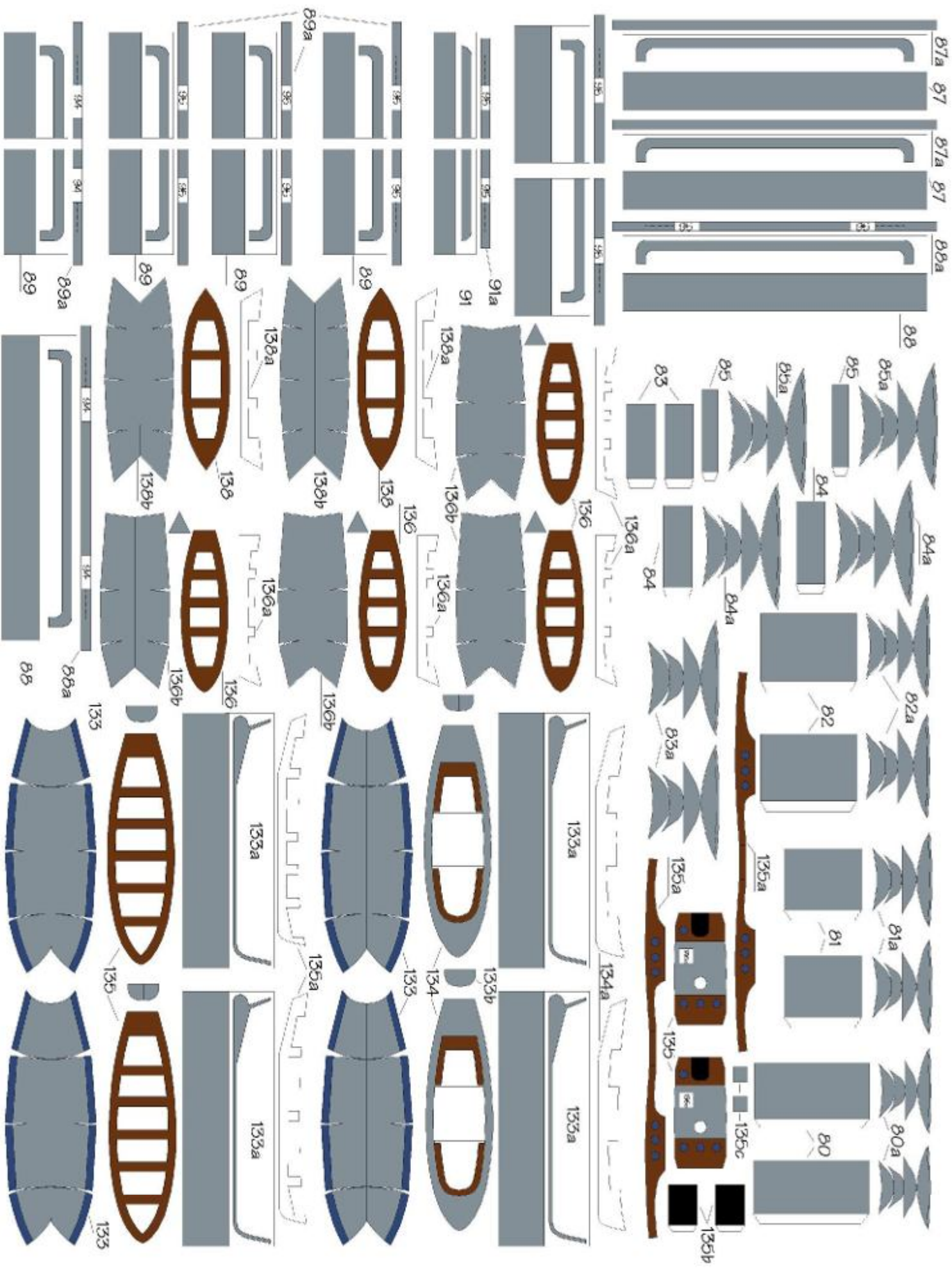

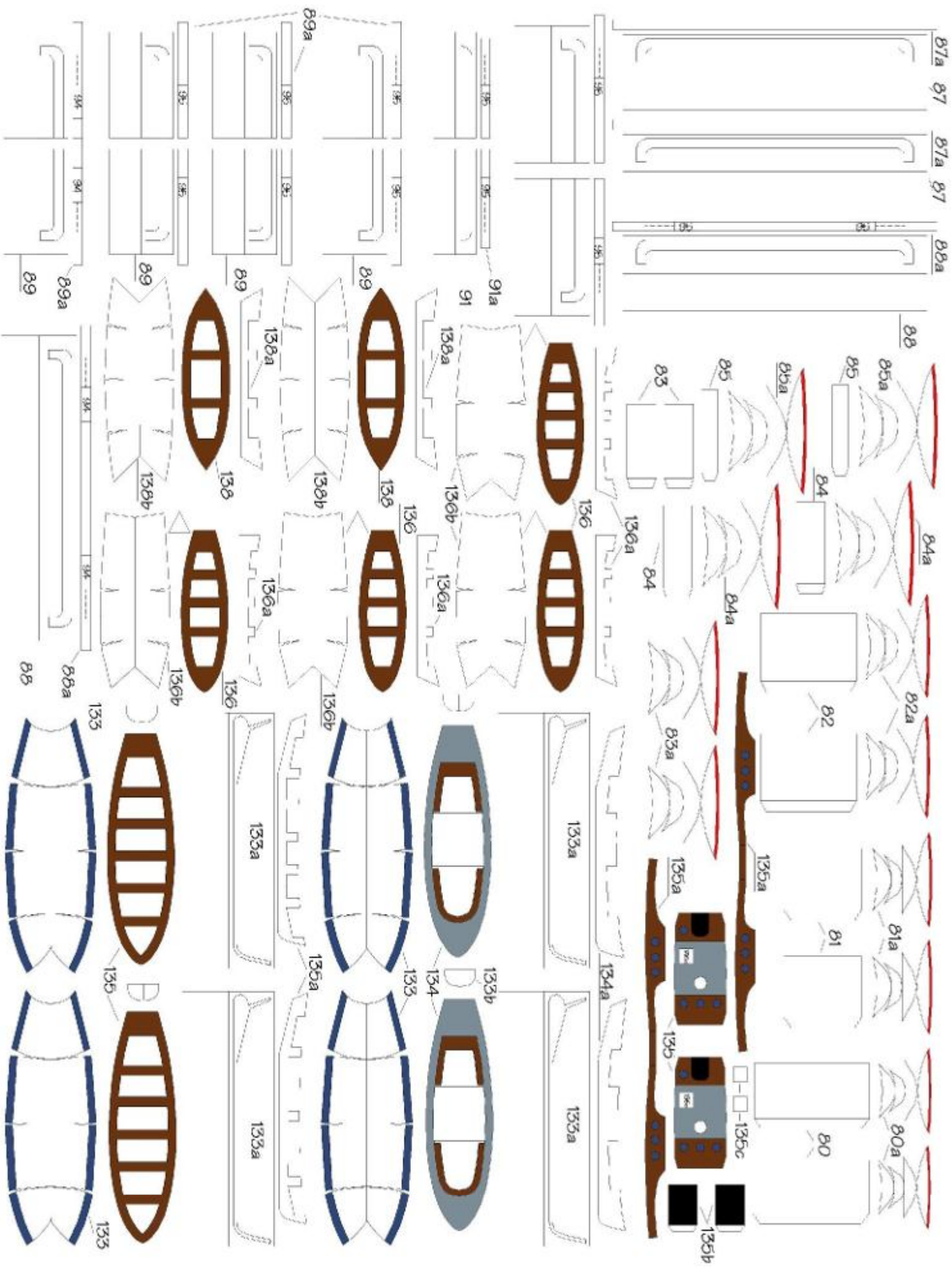

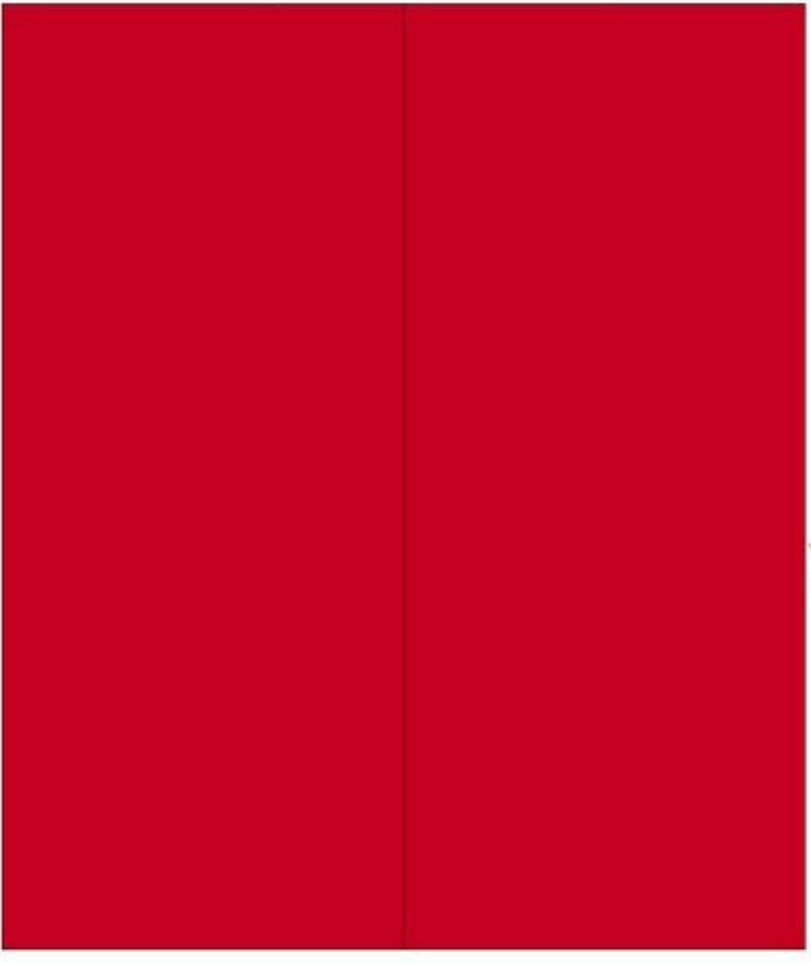
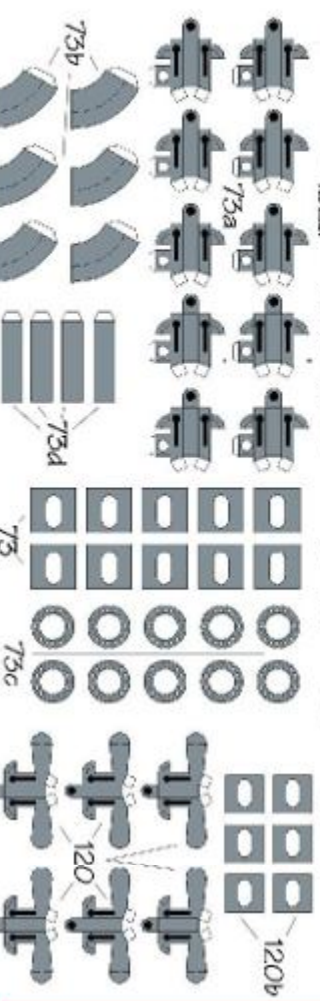
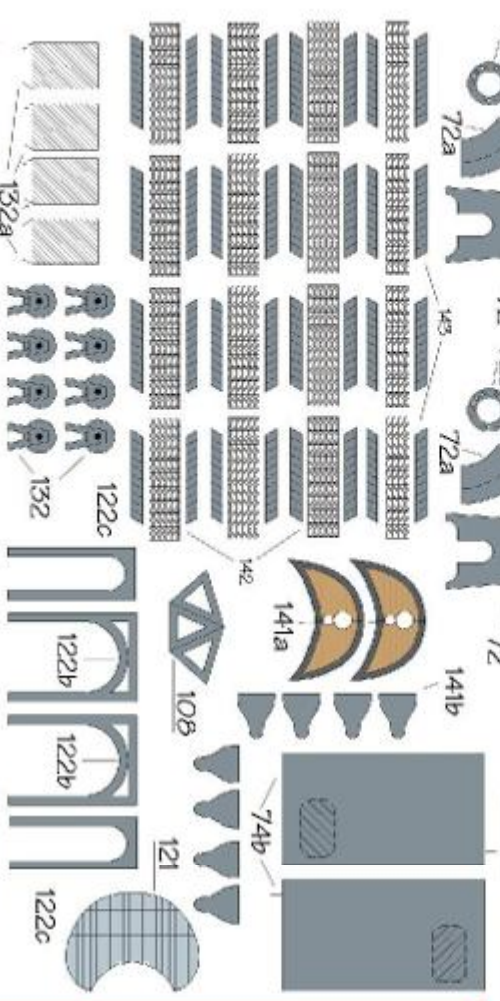
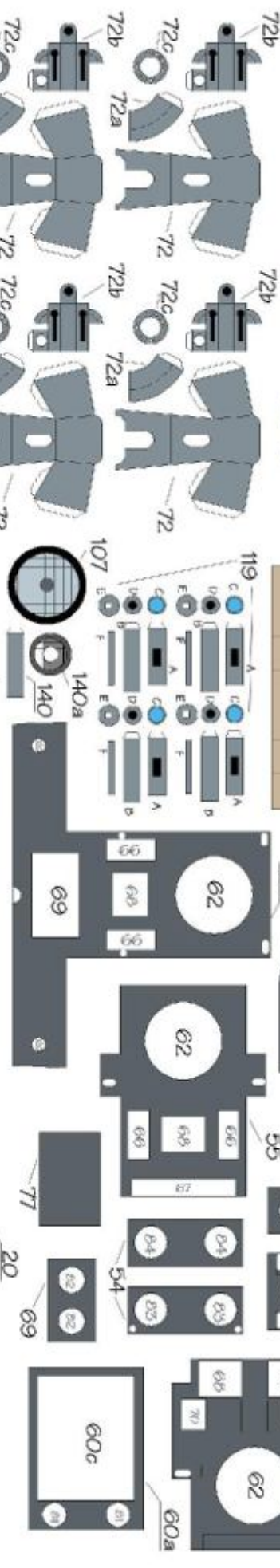
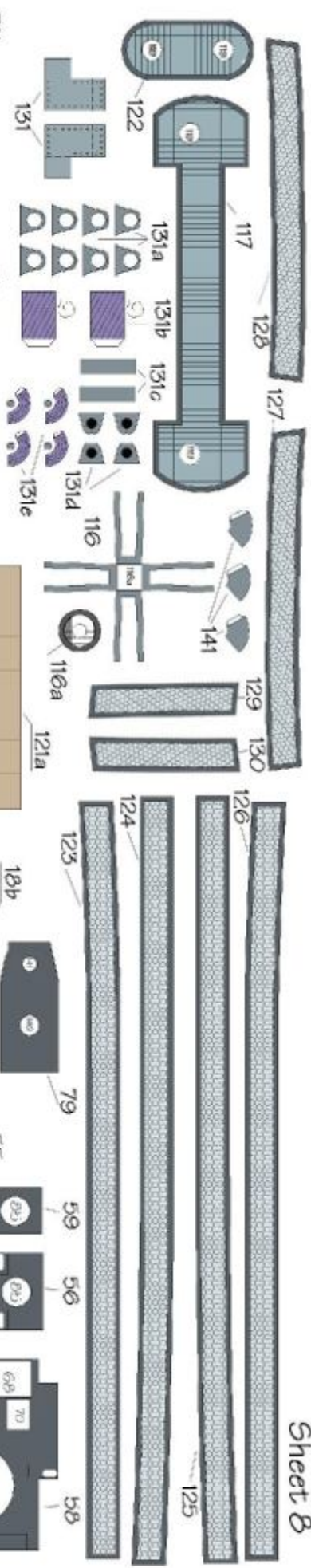

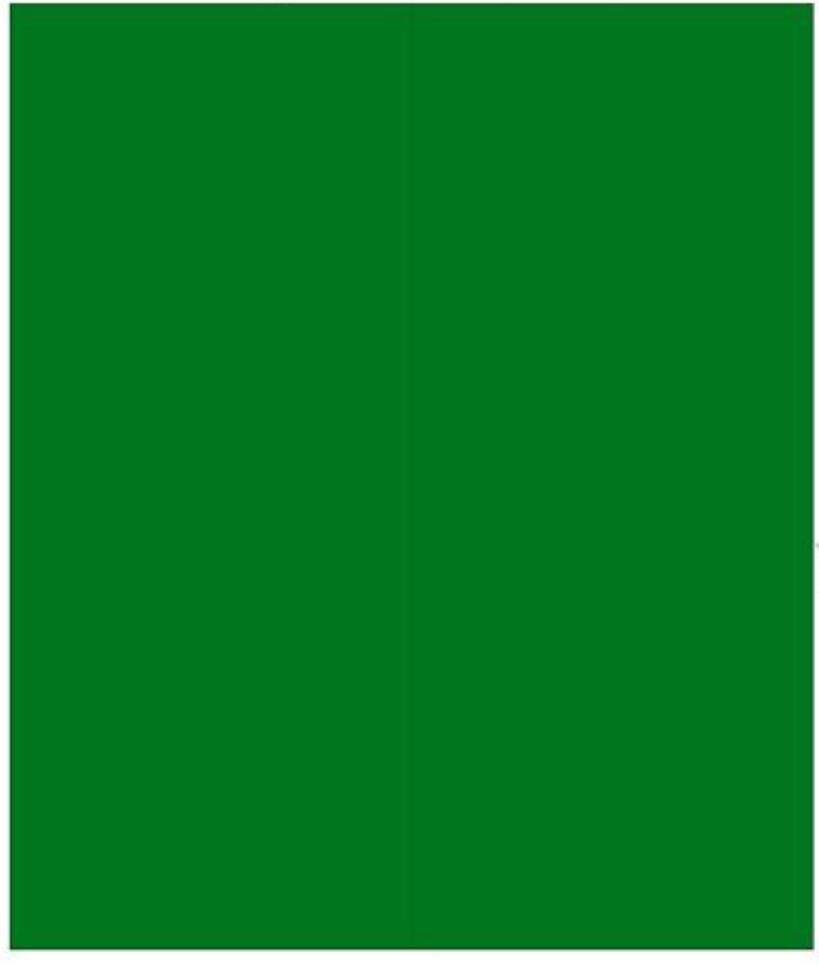
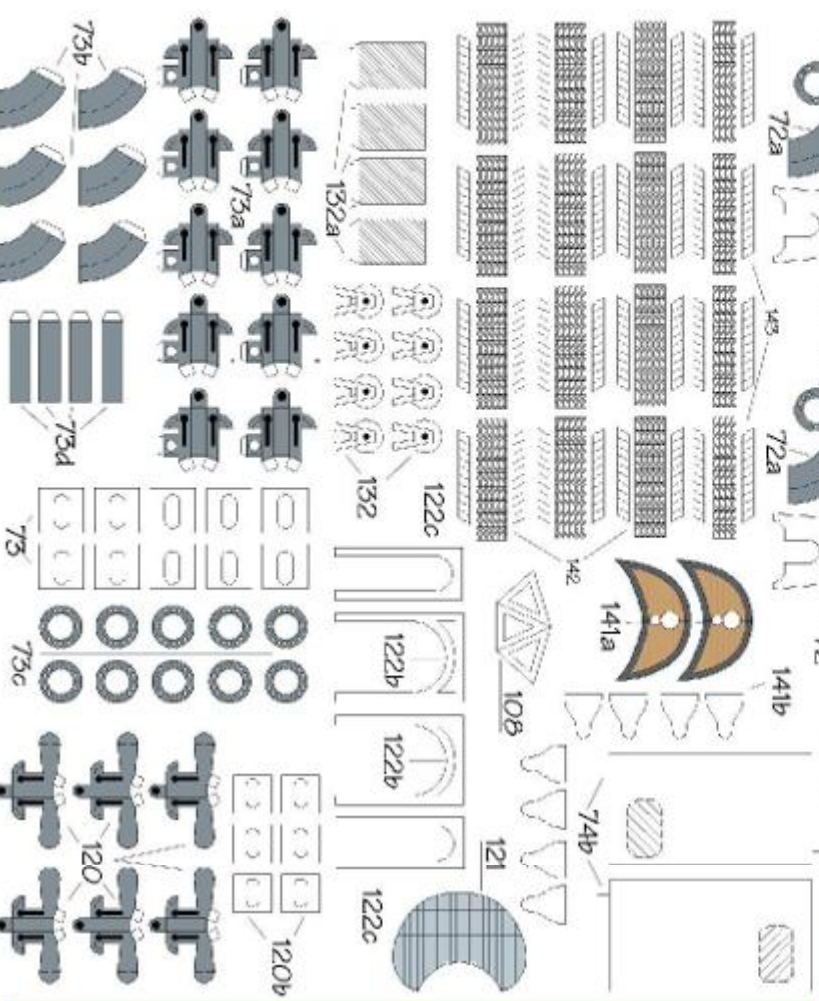
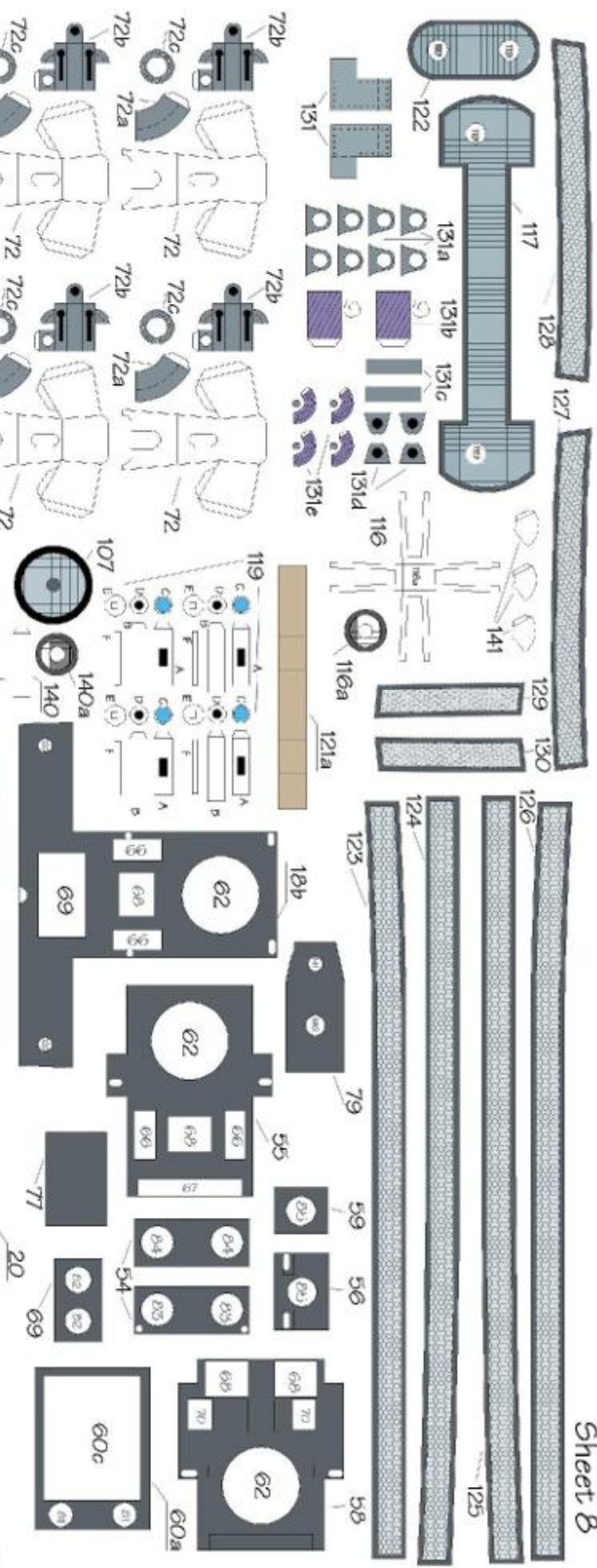

Templates

scale 1:250

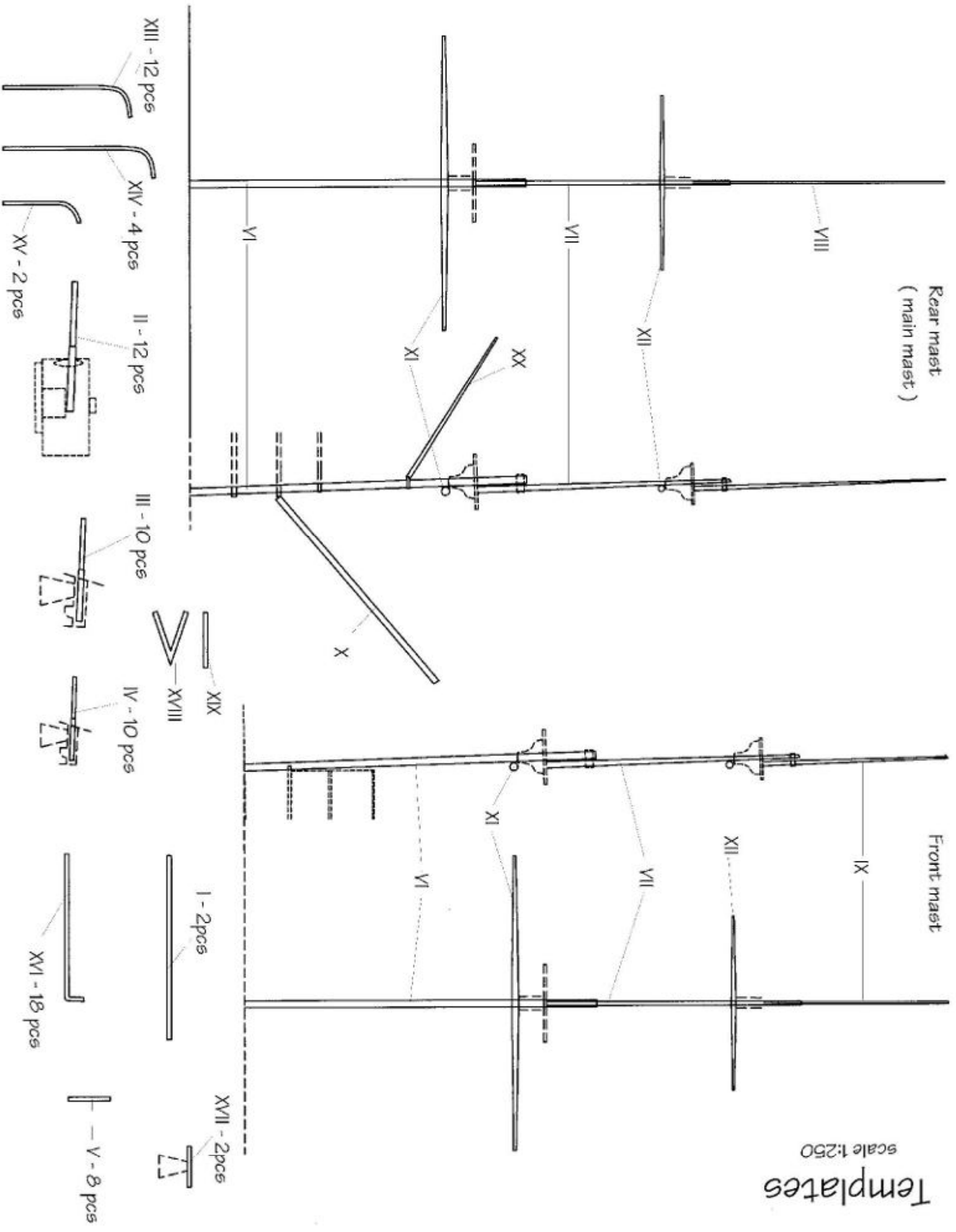

Rear mast
(main mast)

Front mast